



# PUZZLE-A002

---

## Next-Gen Network

[www.ieiworld.com](http://www.ieiworld.com)





## IEI PUZZLE Series Products

# Aiming to The Future with Next Generation Network Appliance

### Proprietary Network Appliance

A Proprietary network appliance is a specialized electronic device that plugs into a network that is optimized for one specialized network purpose like switching, routing, protecting in a network environment. Proprietary network appliances include as Router, Load Balance, Bandwidth Management, Gateway security, WAN Optimization, application delivery controller (ADC), Next Generation Firewall (NGFW), Unified Threat Management (UTM), Intrusion detection system (IDS).

### uCPE (Universal Customer Premise Equipment)

uCPE consists of virtual network functions (VNFs) running on a standard operating system hosted on an open server with NFV technology.

Now with NFV technology, we can create several virtual machine and install these VNFs in a x86 or ARM based uCPE. VNFs could include popular software services such as a virtual firewall, virtual load-balancing, or other software-defined wide area network (SD-WAN) service. Besides with NFV Orchestration, uCPU could be an Edge computing or an AI inference computing systems.

# PUZZLE is Ready for Proprietary Network Appliance



## Unified Threat Management (UTM)

Unified threat management or UTM is a single network appliance for all-inclusive security functions, such as network firewall, intrusion detection/prevention system (IDS/IPS), anti-virus gateway, anti-spam gateway, VPN, content filtering, load balancing, data loss prevention and appliance monitoring.

UTM appliances offer cost-effective, all-in-one security ideal for small/medium businesses, remote offices and retail networks.



## Intrusion Detection System (IDS)

An intrusion detection system (IDS) is a device that monitors a network or systems for malicious activity or policy violations. Any malicious activity or violation is typically reported either to an administrator or collected centrally using a security information and event management (SIEM) system. A SIEM system combines outputs from multiple sources, and uses alarm filtering techniques to distinguish malicious activity from false alarms.



## Wireless Gateway

A wireless gateway routes packets from a wireless LAN to another network, wired or wireless WAN. It may be implemented as software or hardware or combination of both. Wireless gateways combine the functions of a wireless access point, a router, and often provide firewall functions as well. They provide network address translation (NAT) functionality, so multiple user can use the internet with a single public IP. It also acts like a dynamic host configuration protocol (DHCP) to assign IPs automatically to devices connected to the network.



## WAN Optimization

WAN optimization or WAN acceleration is a collection of techniques to enhance the efficiency of data flow across a wide area network (WAN). The goal of WAN optimization is to speed up the data transfer, to reduce latency and insure bandwidth of access to critical applications and information. The most common industrial WAN connection is from branch to headquarters.



## Next Generation Firewall (NGFW)

Both NGFW and traditional firewalls aim to serve the same purpose of protecting an organization's network and data assets, but the most important differences between traditional and next-generation firewalls is that NGFW offer a deep-packet inspection function that goes beyond simple port and protocol inspection by inspecting the data carried in network packets.



## Application Delivery Controller

An application delivery controller (ADC) is a computer network device to improve the performance of web applications in a datacenter and it also could be a part of an application delivery network (ADN). In order to deal with the increasing of Internet traffic, application delivery controller (ADC) also provide load balancing, and support multi-tenancy for deployment at data centers and a large number of sessions with a fast transaction rate.

## Support Various Expansion Card

### Standard PCIe Slots

- PUZZLE-A002 support Two PCIe x4 slots.
- Support smart NIC cards and accelerator cards including CPU accelerator, GPU accelerator, FPGA accelerator and VPU accelerator

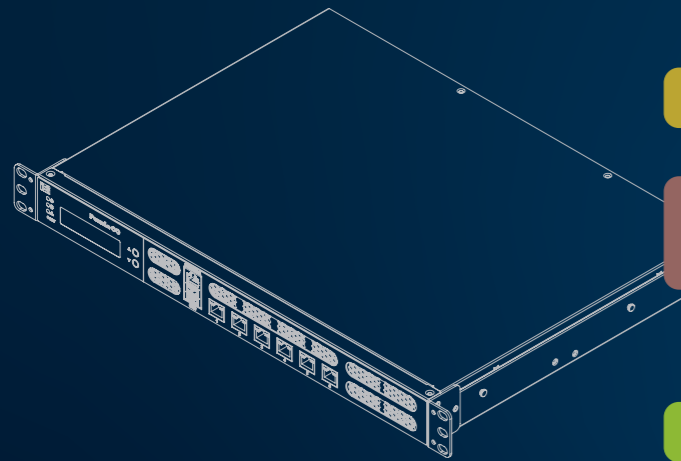

System Fan

Two 2.5" SSD/HDD bays

- Cable-less design

LCM Indicator

2 x DDR4 2400MHz Non-ECC UDIMM Up to 32GB

Next-gen AMD R-Series RX-421ND Quad-core 2.1 GHz CPU (Turbo Core up to 3.4 GHz)

PCIe mini slots support USB 2.0

SIM card slot for 3G, 4G, LTE SIM card

M.2 A key slot support PCIe x1, and USB 2.0

CPU Fan

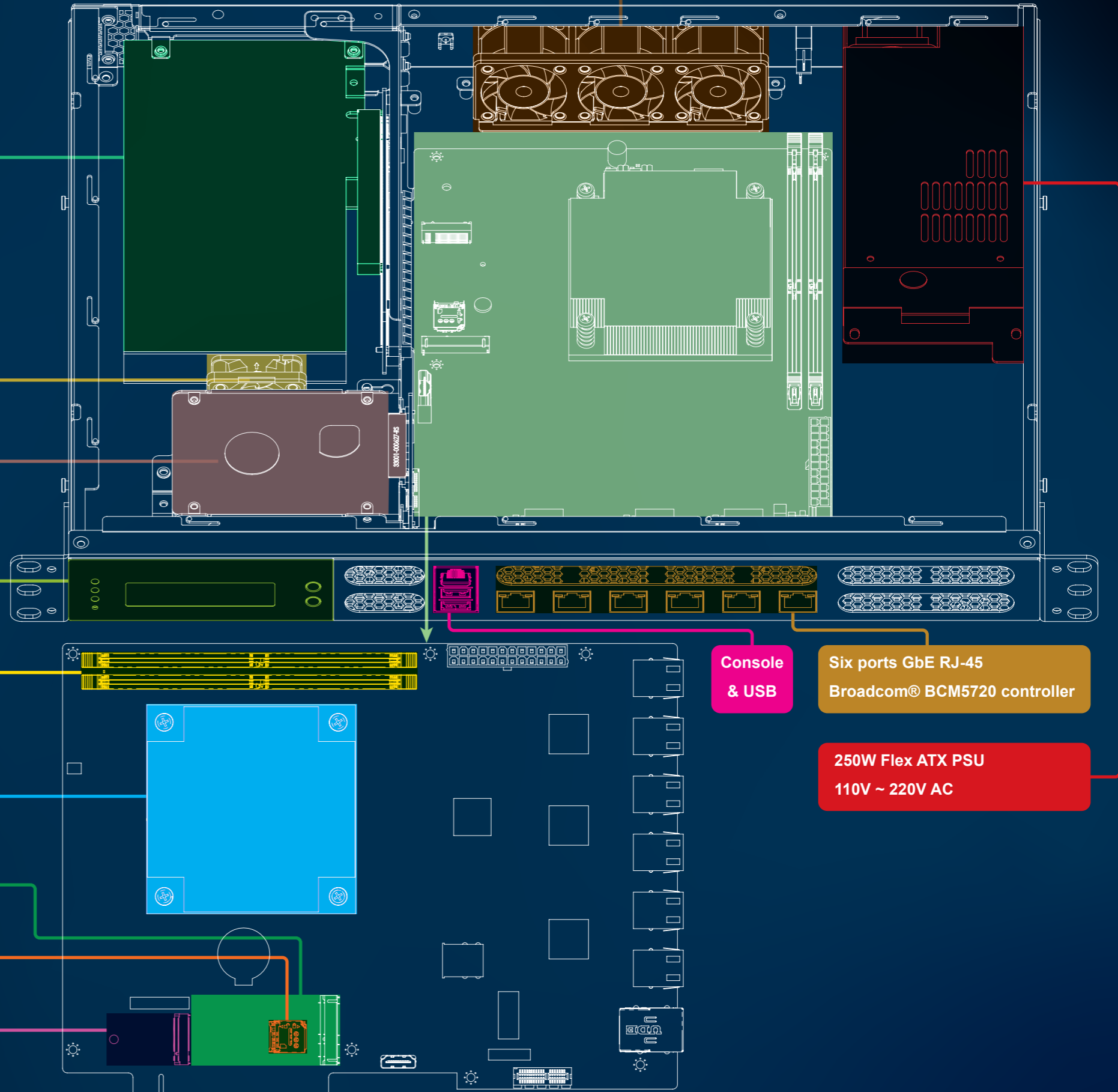

Console & USB

Six ports GbE RJ-45  
Broadcom® BCM5720 controller

250W Flex ATX PSU  
110V ~ 220V AC

## PUZZLE-A002 supports AMD Embedded R-Series SoC RX-421ND

Equipped with a next-gen AMD R-Series RX-421ND quad-core 2.1 GHz CPU (Turbo Core up to 3.4 GHz) with up to 32GB dual-channel DDR4 RAM, the PUZZLE-A002 enables lightning-fast multi-tasking with low power consumption with a six ports of 1GbE (Broadcom 5740) configuration. With a hardware-accelerated AES-NI encryption engine, the PUZZLE-A002 also provides unmatched encryption performance to boost system performance while processing the safety of sensitive data.

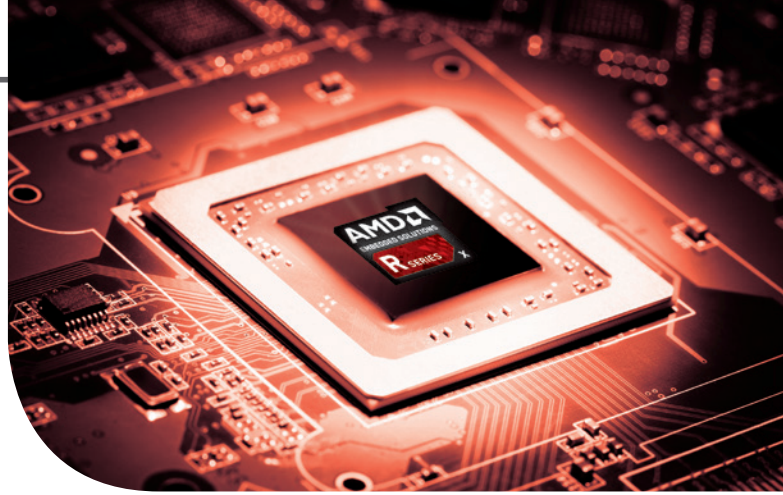

### AMD Embedded R-Series SoC

For compute-intensive workloads and complex algorithm processing, the AMD Embedded R-Series SOC enables system designers to leverage the benefits of 1.0-compliant Heterogeneous System Architecture (HSA) technology to boost parallel processing performance to new heights. These performance attributes are complemented with dynamic power management capabilities and other key benefits, which, together, distinguish the AMD Embedded R-Series SOC as an ideal fit for communications/networking.

### PUZZLE-A002 System Block Diagram

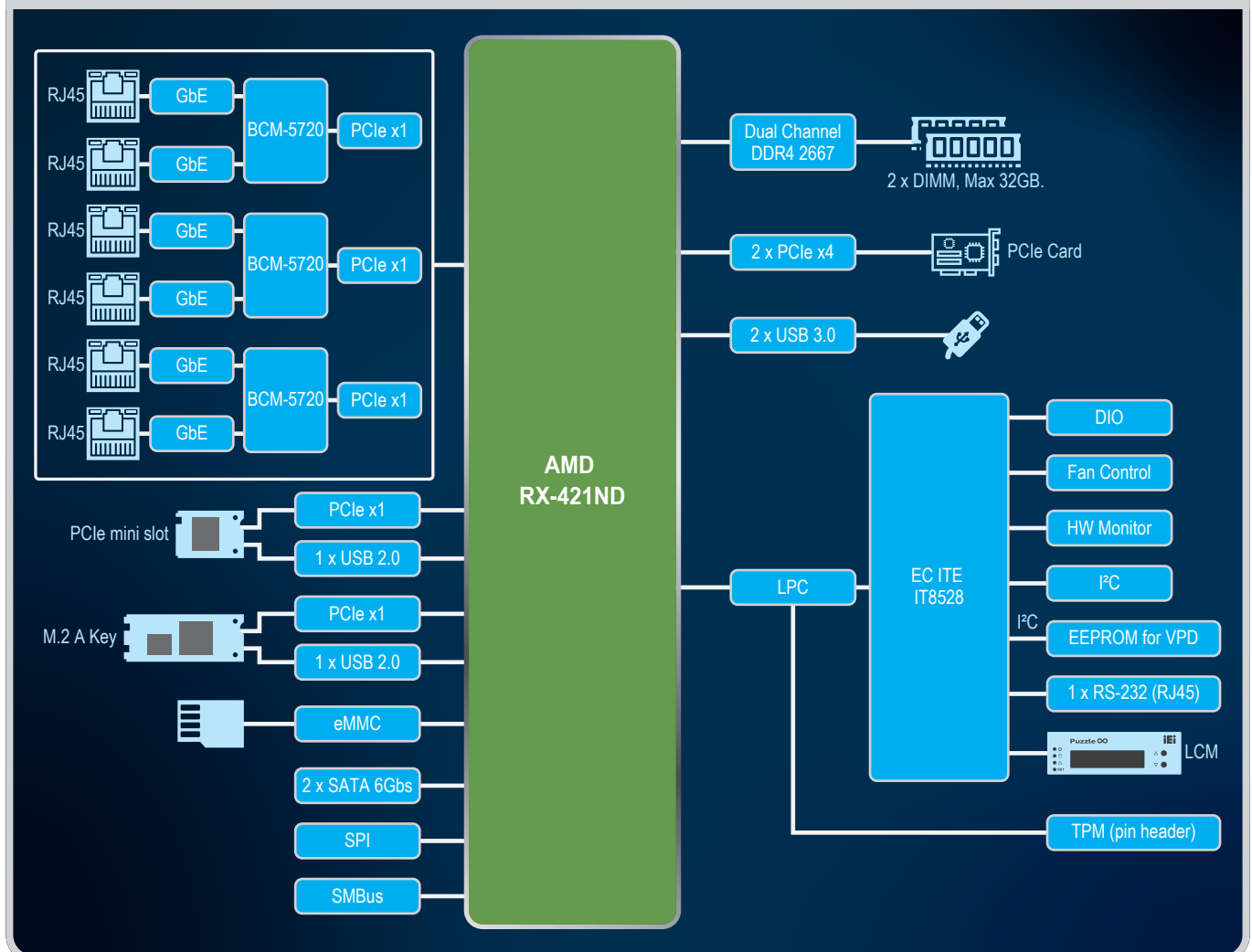

## PUZZLE-A002 Potential with Two PCIe Slots

The PUZZLE-A002 features two PCIe (Gen3 x4) slots, allowing for installing full height, 200mm length Standard PCIe card, such as single/dual-port 10GbE NICs to accelerate applications that demand higher bandwidth such as virtualization, media workflows, and backup/restoration tasks for an ever-growing amount of data.

Besides, expansion Card provides extra functions and computing power for the network appliance, Edge computing and AI inference, computing systems. 4G, 5G, WiFi could be supported by PCIe mini card or M.2 card. Adding a Smart NIC card will increase the performance of system and get specific network functions. Adding accelerator cards like GPU card, FPGA card and VPU card will provide extra performance for a Edge Computing or an AI Inference Computing system.

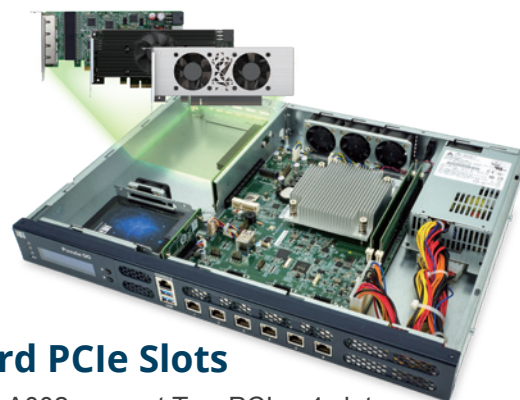

### Standard PCIe Slots

- PUZZLE-A002 support Two PCIe x4 slots.
- Support full height, 200mm length Standard PCIe card.
  - **AI accelerating Card:** VPU, FPGA, GPU card...etc.
  - **High Speed:** 10GbE card, Fiber card
  - **I/O Card:** Serial port card, USB card, LAN card...etc.
  - **Wireless Card:** WiFi card, mobile wireless card...etc.
  - **Storage Card:** SAS, RAID card

### Two PCIe x4 Expansion Slots



| P/N                       | QNAP<br>QM2-2P-384<br>QM2-2P-344 | IEI<br>GPOE-4P-R10<br>GPOE-2P-R10 | GP GPU                       | GT1030                      |
|---------------------------|----------------------------------|-----------------------------------|------------------------------|-----------------------------|
| Description               | Dual M.2 PCIe SSD expansion card | 2-port/4-port PoE card            | Inferencing accelerator card | GPU card                    |
| Form Factor/<br>Interface | Low-Profile<br>PCIe 3.0 x8       | Low-Profile<br>PCIe x1            | Low-Profile<br>PCIe Gen3 x16 | Low-Profile<br>PCIe Gen3 x4 |

## Smart Fan Operation

Users can define CPU fan and system fan speed and temperature profile in the BIOS menu. When the system is in idle or running less demanding tasks, smart fan is able to bring down the level of noise produced by rotating fans. The adjustable settings allow the PUZZLE-A002 to be quieter during operation while extending the fan's lifespan, enhancing system stability and durability.

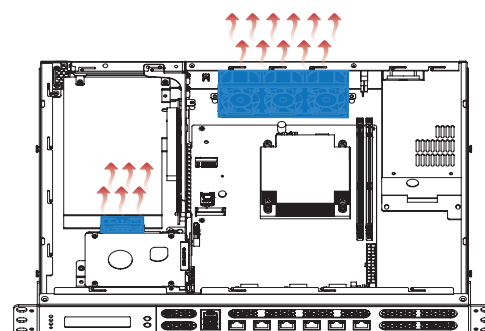

### PUZZLE Series

With fan speed and temperature trigger settings set, the fan speed can change seamlessly according to temperature readings.

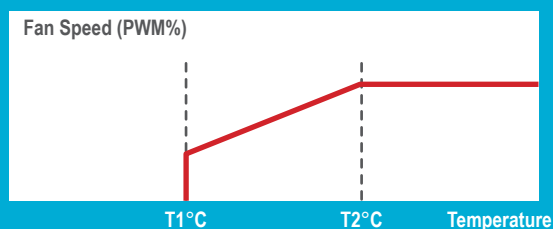

### Traditional System

Traditional system fan operation is detected by system's ON (fan at full speed) and OFF statuses.

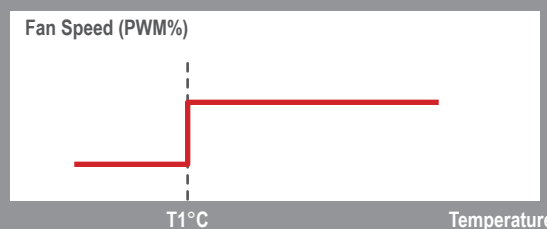



## Protecting Integrity and Authenticity of PUZZLE-A002

PUZZLE-A002 support TPM (Trusted Platform Module) which offers a broad portfolio of standardized security controllers to protect the integrity and authenticity of systems. With a secured key store and support for a variety of encryption algorithms, TPM security chips provide robust protection for critical data and processes through their rich functionality.

### What is a TPM?

Trusted Platform Module (TPM) is an international standard for a secure cryptoprocessor that can securely store critical data such as passwords, certificates and encryption keys. TPM is a dedicated microcontroller designed to secure hardware by integrating cryptographic keys into devices and is used for secured crypto processes within computing devices as well as for secured storage of critical data. TPMs are typically used in business laptops, routers and embedded and IoT devices. The technical TPM specification was written by an industry consortium called Trusted Computing Group (TCG).

### H/W Features

| Solution                  | Infineon<br>SLB9660 TT1.2  | SLB9665TT2.0   |
|---------------------------|--|--|
| Features                  |    |  |
| Secure Startup            | Root of Trust Measurement of early boot devices  |  |
| Anti H/W Attack           | Sensors and active shield  |  |
| TSS API Support           | MS-CAPI/PKCS#11, #12   |  |
| H/W Certification         |   |  |
| Management Tool Function  | <ol style="list-style-type: none"> <li>1. TPM management</li> <li>2. File &amp; Folder En/De-cryption</li> <li>3. Personal secure drive</li> <li>4. Secure Email</li> <li>5. Key transferring</li> <li>6. Security policy configuration</li> </ol> |  |
| Market Segment            | Complete TPM1.2/2.0 function   |  |
| TCG Specification         | TCG 1.2/2.0 compliant trusted platform module  |  |
| Interface                 | Low pin count  |  |
| Software Structure        | TCG software stack 1.2 compliant   |  |
| Cryptographic Accelerator | HAS-1/RSA algorithm  |  |

### Ordering Information

| Part No.     | Description  |
|--------------|--|
| TPM-IN01-R20 | 20-pin Infineon TPM1.2 module, software management tool, firmware v4.4 |
| TPM-IN02-R20 | 20-pin Infineon TPM2.0 module, software management tool, firmware v5.5 |

### Pin Assignment

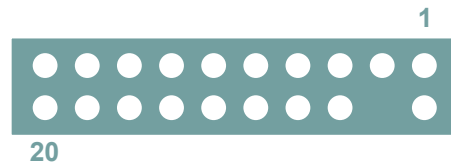

| Pin | Signal  | Pin | Signal | Pin | Signal | Pin | Signal  |
|-----|---------|-----|--------|-----|--------|-----|---------|
| 1   | LCLK    | 6   | VCC5   | 11  | LAD0#  | 16  | SERIRQ  |
| 2   | GND     | 7   | LAD3#  | 12  | GND    | 17  | GND     |
| 3   | LFRAME# | 8   | LAD2#  | 13  | SCL    | 18  | CLKRUN# |
| 4   | KEYWAY  | 9   | VCC3   | 14  | SDA    | 19  | LPCPD#  |
| 5   | LRST#   | 10  | LAD1#  | 15  | SB3V   | 20  | LDRQ#   |

### Dimensions (mm)

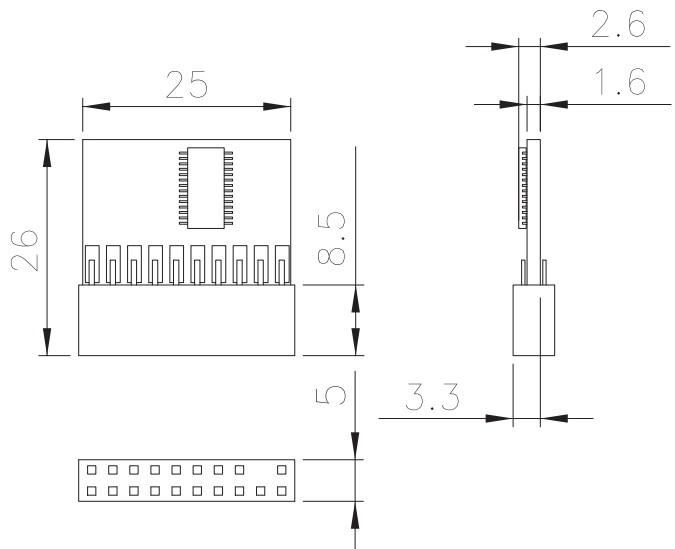

# PUZZLE Software Introduction

## PUZZLE Finder Software AP

Use your PC/Laptop as a development environment.

After installing Ubuntu 16.04 on your PUZZLE, you can install the PUZZLE Finder application on your PC/Laptop. PUZZLE Finder can help users quickly develop environment and network applications, and allow them to perform PUZZLE system management, resource monitoring, version maintenance, software installation, software update and gaining information of CPU, memory, Internet, etc.

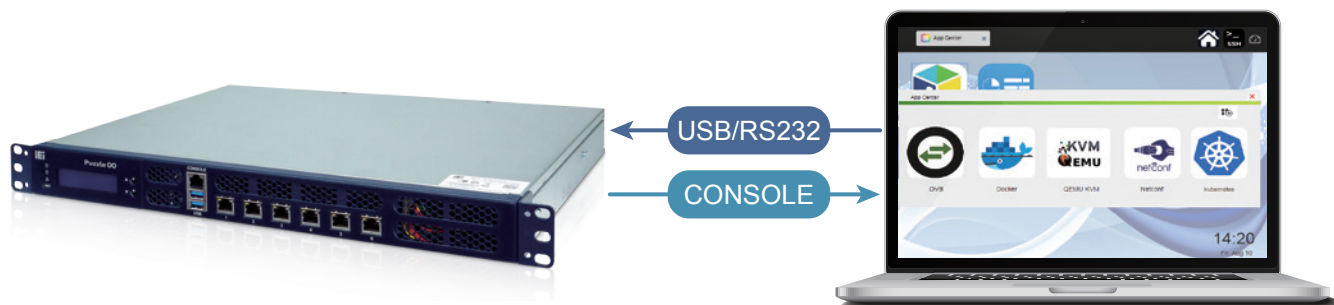

### Easy to Install

The APP center provides the most popular and configured applications.

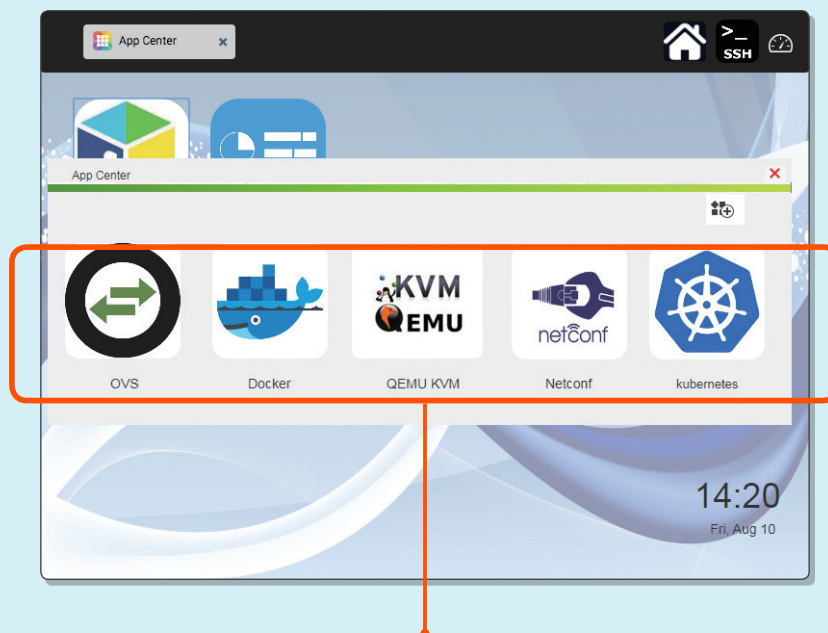

Eliminate cumbersome installation steps; choose the APP you want to install. The APP can be downloaded and automatically installed. You can immediately enjoy the benefits of the software.



# Utilize Virtual Technology, Create Unlimited Value

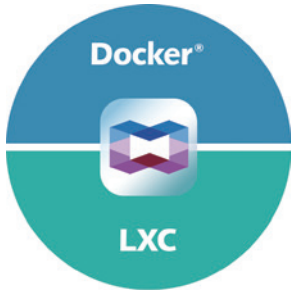

Docker containerization unlocks the potential for Dev and Ops. Freedom of choice, agile operations and integrated security for legacy and cloud-native applications. Implement Docker Lightweight Micro Services on the IEL PUZZLE.

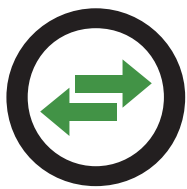

Install the Open vSwitch (OVS) can implement domain cutting, QoS, data monitoring, and support openFlow.



Provide a more efficient Linux virtualization solution. Enhance the efficiency of virtualization by enhancing the operating mode of the CPU through QEMU-KVM.



Automate network configuration with Netconf; accelerate network equipment and services in enterprise in order to lower the cost.



Kubernetes is a system that helps us automate the deployment, expansion, and management of containerized applications.

## PUZZLE System Status Monitoring

Graphical user interface allows you to easily get an overview of the PUZZLE system and monitor resource status of each PUZZLE system you have.



### User Interface



# PUZZLE Series Technology

Virtualization is the process of creating a software-based, or virtual, representation of something, such as virtual applications, servers, storage and networks. Network functions virtualization or NFV is a network architecture concept that uses the technologies of IT virtualization to virtualize entire classes of network node functions into building blocks that may connect, or chain together, to create communication services.

## PUZZLE Series Ecosystem

PUZZLE is about the uCPE consists of software virtual network functions (VNFs) running on a standard operating system hosted on an open server. An ideal uCPE deployment supports a multi-vendor multi-component construction and enables rapid development as well as open multi-vendor systems.

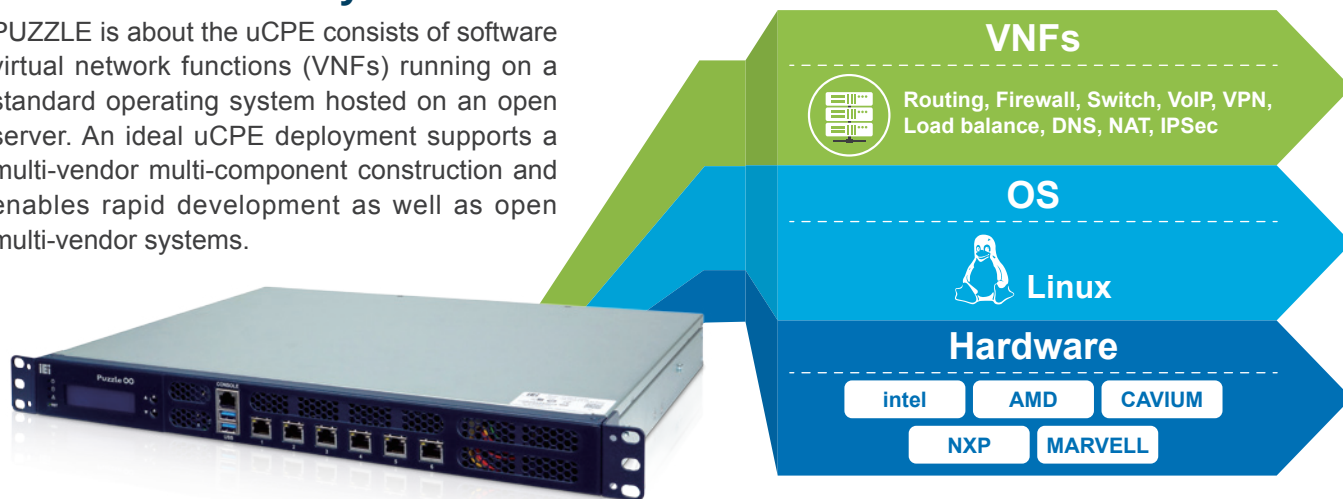

# PUZZLE Series is Ready for Next Generation Network

The following picture completely shows the components of the PUZZLE series. Choose the right components from CPU, NIC, software, manufacturing side, and fit them together. You will create a perfect network appliance.

### Software/ Application

On the left hand side, it shows the S/W support from IEI. IEI will help customers to get device driver, application, other NFV basic software, DPDK, OvS, VPP, OpenDaylight and OpenStack. IEI will also help customers to deploy and install all of the software and build up their own NFV solutions.



### NIC & Bandwidth

On the upper side, it shows the network connection ability of the PUZZLE series. IEI provides four brands of NIC from Aquantia, Intel, Broadcom, Mellanox, and with 1G, 2.5G, 5G, 10G or 25G different kinds of speed.



### System Integration

On the right hand side, it shows the computing ability of the PUZZLE series.

IEI implements 5 major CPU brands, including Intel, AMD, Marvell, NXP, Cavium, and 3 kinds of accelerator cards for edge computing or AI computing .



### Designing & Manufacture

On the bottom side, it shows ARMOR Link cross IEI cross QNAP.

Most of network appliances are about network security. Some of the customers care about where the network appliance is designed and made. Therefore, we provide you two choices, design and manufacture in Taiwan or in China. QNAP factory is in New Taipei City, Taiwan, and ARMOR Link factory is located in Shanghai, China.

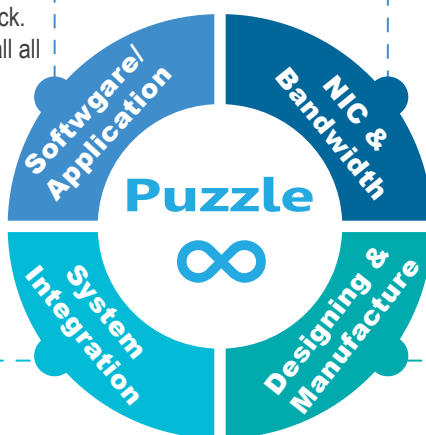

# PUZZLE-A002



1U Rackmount Network Appliance with AMD R-Series RX-421ND processor, Support 6 x GbE RJ-45



## Features

- AMD R-Series RX-421ND quad-core 2.1 GHz processor
- 2 x DDR4 2400MHz Non-ECC UDIMM, up to 32 GB
- Support 6 x GbE RJ-45 via BROADCOM BCM 5720
- 1 x RJ-45 Console, 2 x USB 3.1 Gen 1 (5Gb/s), 2 x USB 2.0, LCM
- 1 x PCIe x8, 2 x 2.5" SATA drive bay, 1 x PCIe mini, 1 x SD slot
- Support two PCIe x4

## Specifications

|                            |  | PUZZLE-A002  |
|----------------------------|--|--|
| Platform                   | Form Factor                                | 1U   |
|                            | CPU  | AMD R-Series RX-421ND processor, 4C, up to 3.4 GHz   |
|                            | Chipset                                    | Integrated in CPU  |
| Memory                     | Memory Technology                          | 2 x DDR4 2400MHz ECC/Non-ECC/RDIMM   |
|                            | Memory Capacity                            | Up to 32GB   |
|                            | Memory Socket                              | 2 x 288-pin DIMM   |
| Network and Security       | Network acceleration and Security function | <ul style="list-style-type: none"> <li>• AES-NI encryption acceleration</li> <li>• AMD Secure Processor</li> <li>• Secure boot with AMD Hardware Validated Boot (HVB)</li> </ul> |
|                            | TPM  | 1 x TPM 2.0 Pin header   |
| Networking                 | Ethernet IC                                | 1 GbE NIC: Broadcom® BCM5720   |
|                            | Ethernet Port                              | 6 x 1GbE RJ-45 LAN ports   |
|                            | Network Module Slot                        | N/A  |
| Expansion slot             | PCIe slot                                  | 2 x PCIe x4 slot   |
|                            | PCIe mini card slot                        | 1 x PCIe mini card (PCIe, USB 2.0, Micro SIM slot)   |
|                            | M.2  | 1 x M.2 A key (PCIe & USB 2.0)   |
| Storage                    | Storage                                    | 2 x 2.5" SATA HDD/SSD bay  |
|                            | eMMC                                       | 8GbE   |
|                            | SD card                                    | N/A  |
| External I/O               | USB 3.1                                    | 2 x USB 3.1 Gen 1 (5Gb/s)  |
|                            | Console                                    | 1 x RJ-45  |
| Internal I/O               | M.2  | 1 x M.2 A key (PCIe & USB 2.0)   |
|                            | HDMI                                       | N/A  |
|                            | USB 3.1                                    | 1 x USB 3.1 Gen 1 (5Gb/s)  |
|                            | USB 2.0                                    | 2 x USB 2.0  |
| Power and Mechanical       | Power Switch                               | 1 x Power Switch   |
|                            | Reset Button                               | 1 x Reset Button   |
|                            | Power Input                                | 100 V ~ 240 V  |
|                            | Type/Watt                                  | ATX Power 250W<br>90V~264V AC  |
|                            | Processor Cooling                          | 1 x Passive CPU Heatsink   |
|                            | System Cooling                             | 4 x Cooling Fans with Smart Fan  |
|                            | Antenna Port                               | 1 x Antenna port   |
| Physical and Environmental | Storage Temperature                        | -10°C ~ 50°C   |
|                            | Operating Temperature                      | 0 ~ 40°C (32 ~ 104°F)  |
|                            | Operating Humidity                         | 5% ~ 90% non-condensing  |
|                            | Dimensions (W x H x D) (mm)                | 430 x 320 x 44.2   |
|                            | Weight                                     | 5kg  |
| OS and Certifications      | Certification                              | CE / FCC   |
|                            | Operating System                           | Linux Ubuntu 16.04.04  |
| Indicators                 | LCM  | LCM, 2 buttons   |
|                            | LED  | 1 x Power LED<br>1 x Storage LED<br>1 x Alert LED  |

## ▶ I/O Interface

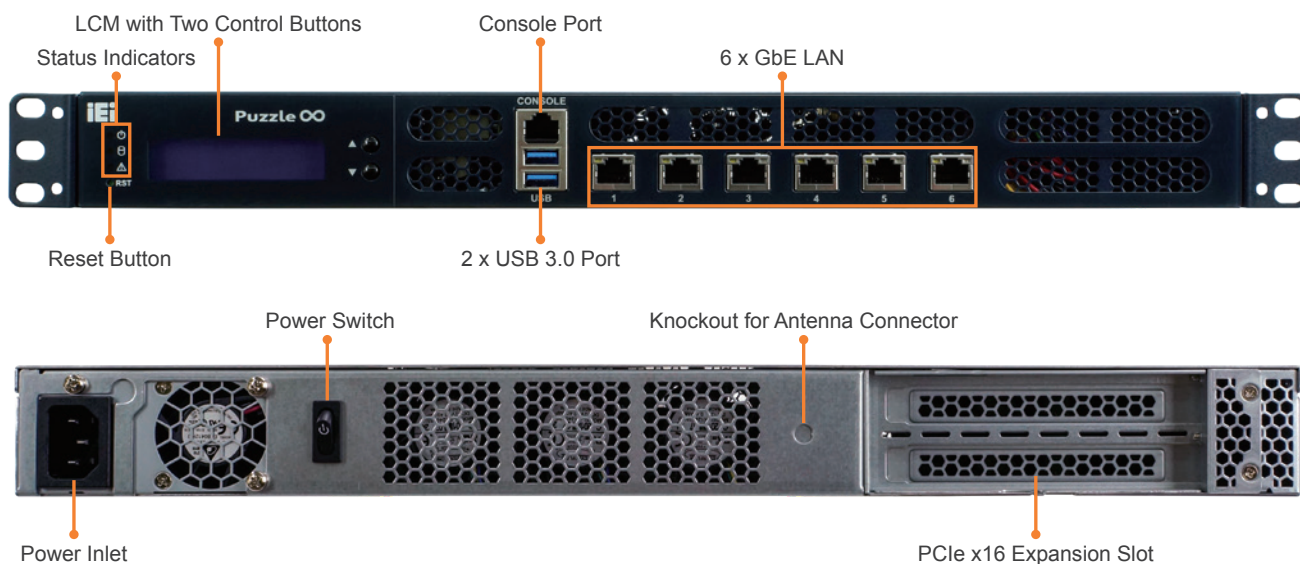

## ▶ Dimensions (Unit: mm)

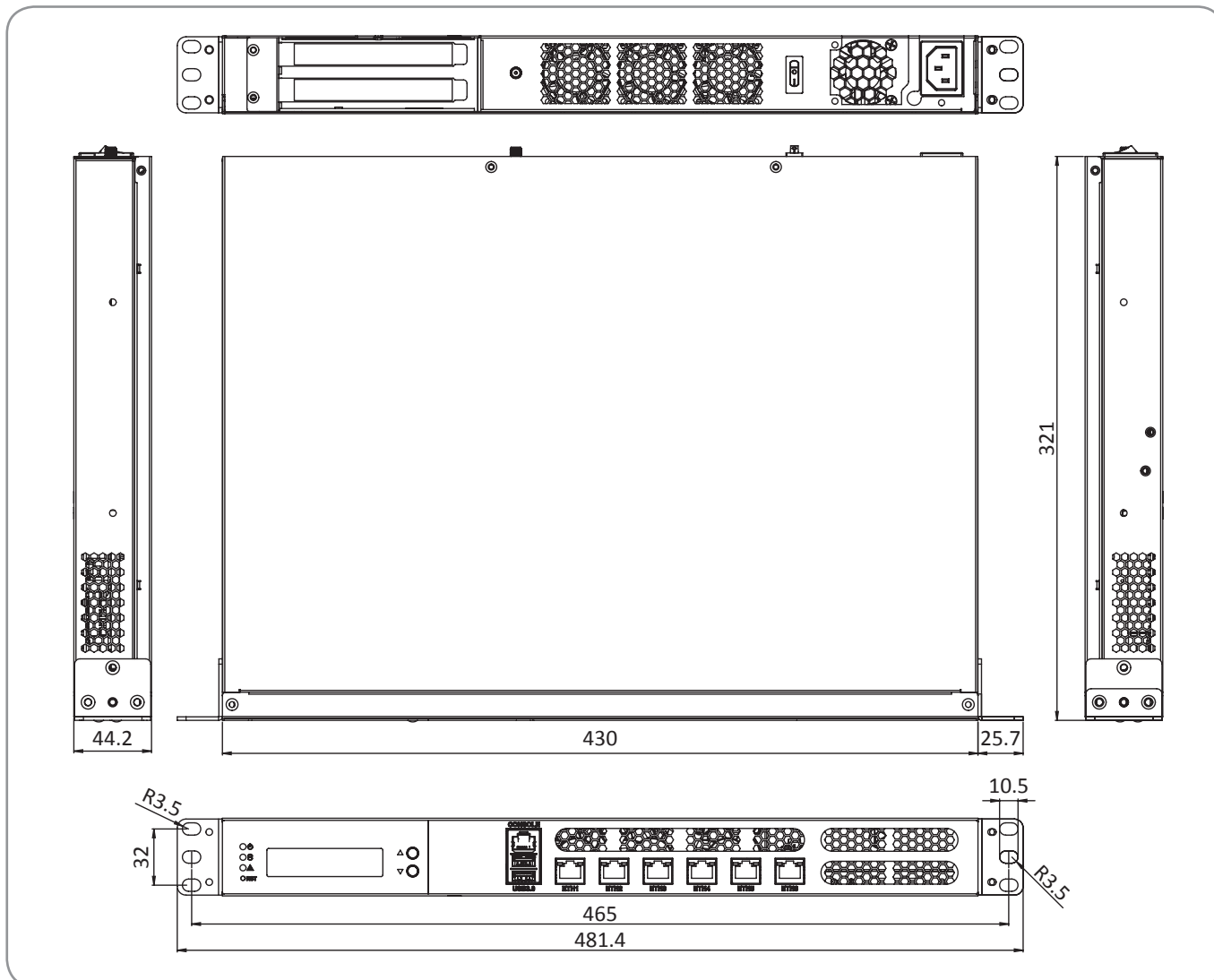

## ▶ Ordering Information

| Part No.               | Description   |
|------------------------|---|
| PUZZLE-A002-MF1-R10    | 1U Rackmount Network Appliance with AMD® RX-421ND processor, two DDR4 slots, and six 1GbE, two PCIe x4 expansion, RoHS      |
| PUZZLE-A002-MF1/8G-R10 | 1U Rackmount Network Appliance with AMD® RX-421ND processor, 8GB DDR4, one 256GB SSD, six 1GbE, two PCIe x4 expansion, RoHS |

## ▶ Packing List

|                              | PUZZLE-A002-MF1 | PUZZLE-A002-MF1/8G |
|------------------------------|-----------------|--------------------|
| Power cord                   | 1               | 1                  |
| Heatsink                     | 1               | 1                  |
| Rack mounting ears           | 2               | 2                  |
| SCREW for Rack mounting ears | 6               | 6                  |
| USB to console cable         | Option          | 1                  |
| RS232 to console cable       | 1               | Option             |
| Slide rail                   | Option          | Option             |

## ▶ Options

| Item                   | Part No.            | Description   |
|------------------------|---------------------|---|
| Slide rail             | RAIL-B02            | New rail kit for new 1U & 2U NAS: TVS-471U, 1253U, etc  |
| USB to console cable   | 32013-004000-100-RS | ROUND CABLE; LAN CABLE; FTDI Console Cable; 2; 1800MM; (A)USB A TYPE 4P MALE+PCB:FTDI_FT232RL; (B)RJ-45 8P8C; RoHS                            |
| RS232 to console cable | 32005-005100-100-RS | ROUND CABLE; RS-232/422/485; PUZZLE RS-232 Cable; 2; 500MM; 24AWG; (A) D-SUB 9P MALE+#4-40 Screw; (B)RJ-45 PLUG 8P8C; ONE PCS PKG; TC&C; RoHS |

### Headquarters

威強電工業電腦 IEI Integration Corp.

No. 29, Zhongxing Rd., Xizhi Dist., New Taipei City 221, Taiwan  
 TEL : +886-2-86916798 / +886-2-26902098 FAX : +886-2-66160028  
 sales@ieiworld.com www.ieiworld.com

### America

IEI Technology USA Corp.

138 University Parkway, Pomona, CA 91768  
 TEL : +1-909-595-2819 FAX : +1-909-595-2816  
 sales@usa.ieiworld.com usa.ieiworld.com

### China

威強電工業電腦 IEI Integration (Shanghai) Corp.

上海市闵行莘庄工业区申富路515号  
 515, Shen Fu Rd., Xin Zhuang Industrial Develop Zone, Shanghai, 201108, China  
 TEL:+86-21-3116-7799 FAX:+86-21-3462-7797  
 sales@ieiworld.com.cn www.ieiworld.com.cn