



PUZZLE-IN002

Next-Gen Network

www.ieiworld.com





IEI PUZZLE Series Products

Aiming to The Future with Next Generation Network Appliance

Proprietary Network Appliance

A Proprietary network appliance is a specialized electronic device that plugs into a network that is optimized for one specialized network purpose like switching, routing, protecting in a network environment. Proprietary network appliances include as Router, Load Balance, Bandwidth Management, Gateway security, WAN Optimization, application delivery controller (ADC), Next Generation Firewall (NGFW), Unified Threat Management (UTM), Intrusion detection system (IDS).

uCPE (Universal Customer Premise Equipment)

uCPE consists of virtual network functions (VNFs) running on a standard operating system hosted on an open server with NFV technology.

Now with NFV technology, we can create several virtual machine and install these VNFs in a x86 or ARM based uCPE. VNFs could include popular software services such as a virtual firewall, virtual load-balancing, or other software-defined wide area network (SD-WAN) service. Besides with NFV Orchestration, uCPU could be an Edge computing or an AI inference computing systems.

PUZZLE is Ready for Proprietary Network Appliance



Unified Threat Management (UTM)

Unified threat management or UTM is a single network appliance for all-inclusive security functions, such as network firewall, intrusion detection/prevention system (IDS/IPS), anti-virus gateway, anti-spam gateway, VPN, content filtering, load balancing, data loss prevention and appliance monitoring.

UTM appliances offer cost-effective, all-in-one security ideal for small/medium businesses, remote offices and retail networks.



Intrusion Detection System (IDS)

An intrusion detection system (IDS) is a device that monitors a network or systems for malicious activity or policy violations. Any malicious activity or violation is typically reported either to an administrator or collected centrally using a security information and event management (SIEM) system. A SIEM system combines outputs from multiple sources, and uses alarm filtering techniques to distinguish malicious activity from false alarms.



Wireless Gateway

A wireless gateway routes packets from a wireless LAN to another network, wired or wireless WAN. It may be implemented as software or hardware or combination of both. Wireless gateways combine the functions of a wireless access point, a router, and often provide firewall functions as well. They provide network address translation (NAT) functionality, so multiple user can use the internet with a single public IP. It also acts like a dynamic host configuration protocol (DHCP) to assign IPs automatically to devices connected to the network.



WAN Optimization

WAN optimization or WAN acceleration is a collection of techniques to enhance the efficiency of data flow across a wide area network (WAN). The goal of WAN optimization is to speed up the data transfer, to reduce latency and insure bandwidth of access to critical applications and information. The most common industrial WAN connection is from branch to headquarters.



Next Generation Firewall (NGFW)

Both NGFW and traditional firewalls aim to serve the same purpose of protecting an organization's network and data assets, but the most important differences between traditional and next-generation firewalls is that NGFW offer a deep-packet inspection function that goes beyond simple port and protocol inspection by inspecting the data carried in network packets.



Application Delivery Controller

An application delivery controller (ADC) is a computer network device to improve the performance of web applications in a datacenter and it also could be a part of an application delivery network (ADN). In order to deal with the increasing of Internet traffic, application delivery controller (ADC) also provide load balancing, and support multi-tenancy for deployment at data centers and a large number of sessions with a fast transaction rate.

Support Various Expansion Card

Standard PCIe Slots

- PUZZLE-IN002 support One PCIe x16 slots.
- Support smart NIC cards and accelerator cards including CPU accelerator, GPU accelerator, FPGA accelerator and VPU accelerator.

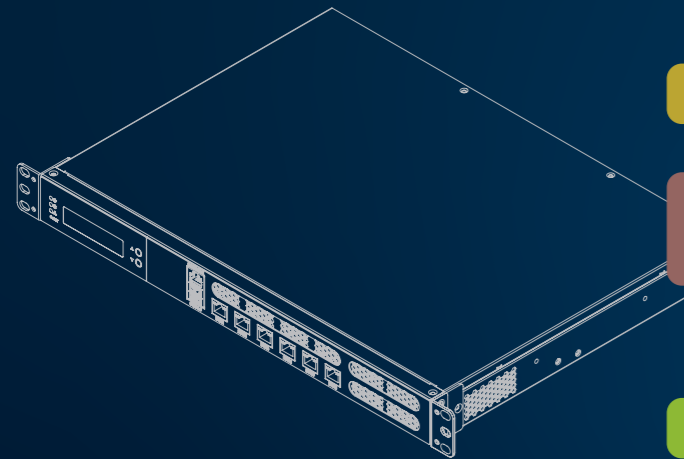

System Fan

Two 2.5" SSD/HDD Bays

- Cable-less design

LCM Indicator

2 x DDR4 2400MHz Non-ECC UDIMM Up to 32GB

New 8th Generation Intel® Core™ “Coffee Lake” Processors
It improves performance by 15% compared to the previous generation.

PCIe mini slots support mSATA, USB 2.0

SIM card slot for 3G, 4G

M.2 A key slot support PCIe x1, and USB 2.0

CPU Fan

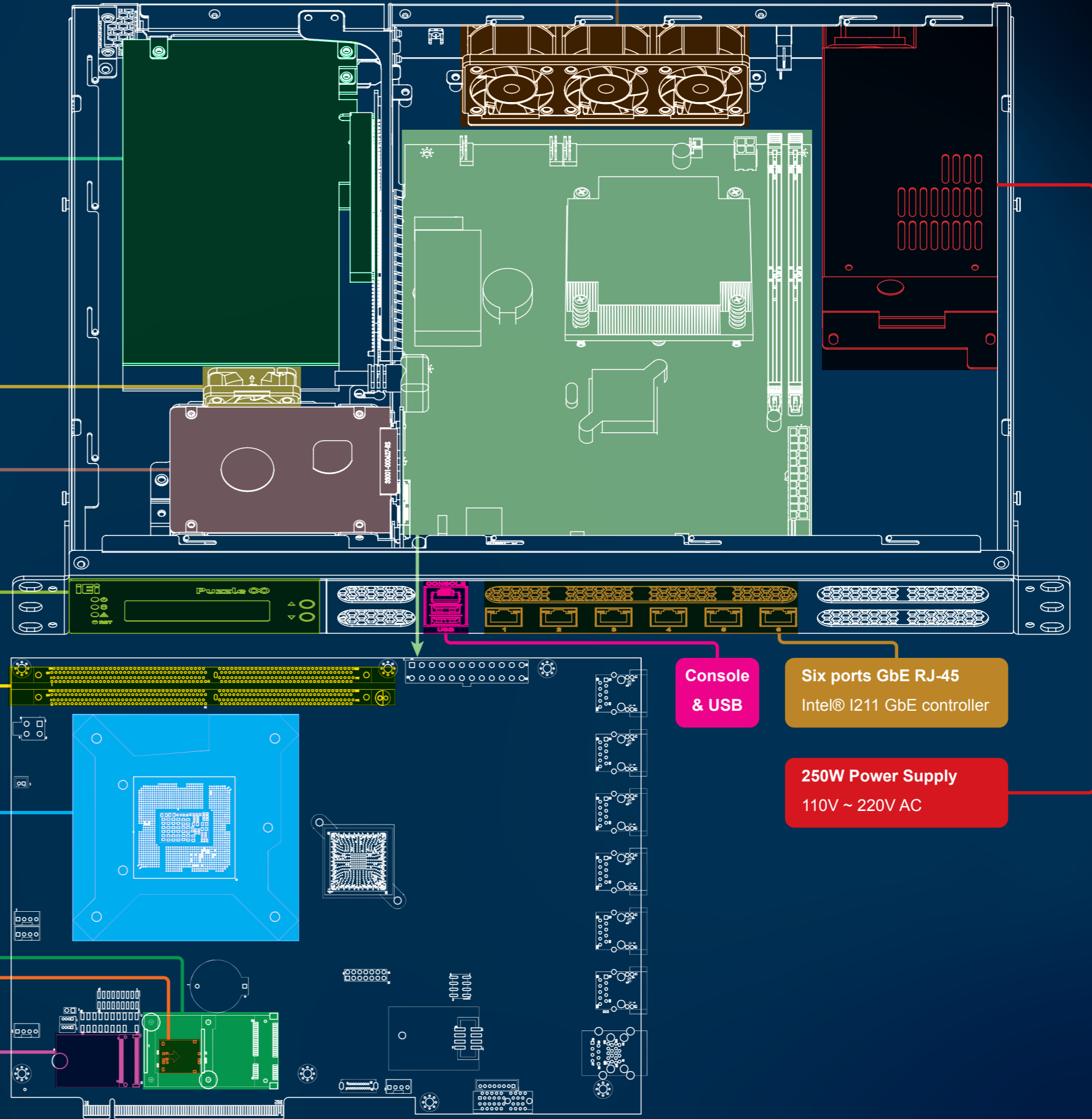

Console & USB

Six ports GbE RJ-45
Intel® I211 GbE controller

250W Power Supply
110V ~ 220V AC

Breakthrough the Bottleneck of DMI3.0

The signal of the one PCIe 3.0 x16 slot directly connect to CPU instead of DMI 3.0 channel. By doing this, the PCIe 3.0 x16 add-on cards can run with lower latency and achieve complete AI card and Networking Module performance.

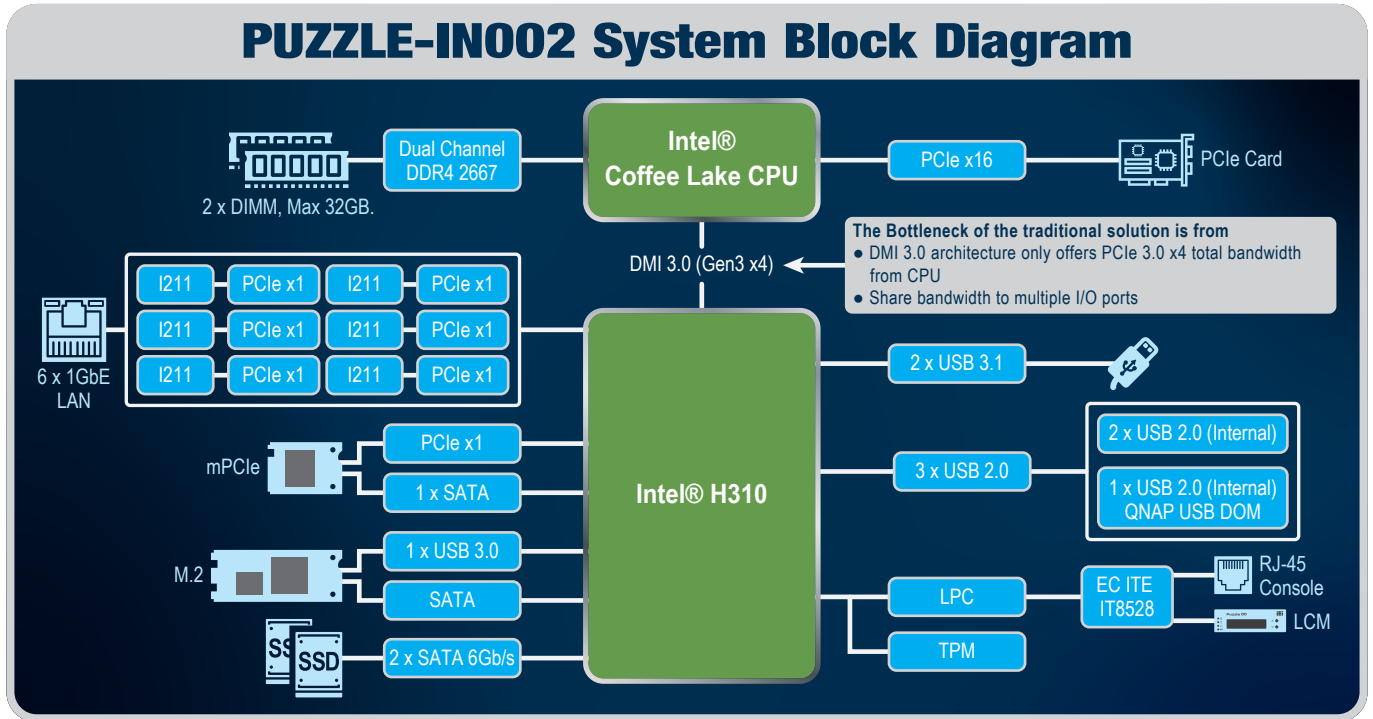

Two PCIe x4/x8 Full Height Expansion Slots



Standard PCIe Slots

- PUZZLE-IN002 support One PCIe x16 slots.
- Support full height, 200mm length Standard PCIe card.
 - **AI accelerating Card:** VPU, FPGA, GPU Card...etc.
 - **High Speed:** 10GbE Card, Fiber Card
 - **I/O Card:** Serial Port Card, USB Card, LAN Card...etc.
 - **Wireless Card:** WiFi Card, mobile wireless card...etc.
 - **Storage Card:** SAS, RAID card

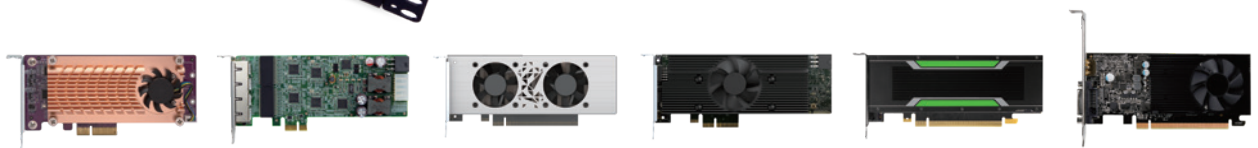

P/N	QNAP QM2-2P-384 QM2-2P-344	IEI GPOE-4P-R10 GPOE-2P-R10	IEI Mustang-F100-A10	IEI Mustang-V100-MX8	GP GPU	GT1030
Description	Dual M.2 PCIe SSD expansion card	2-port/4-port PoE card	FPGA card	VPU card	Inferencing accelerator card	GPU card
Form Factor/Interface	Low-Profile PCIe 3.0 x8	Low-Profile PCIe x1	Low-Profile PCIe 3.0 x8	Low-Profile PCIe 2.0 x4	Low-Profile PCIe Gen3 x16	Low-Profile PCIe Gen3 x4

Smart Fan Operation

Users can define CPU fan and system fan speed and temperature profile in the BIOS menu. When the system is in idle or running less demanding tasks, smart fan is able to bring down the level of noise produced by rotating fans. The adjustable settings allow the PUZZLE-IN001 to be quieter during operation while extending the fan's lifespan, enhancing system stability and durability.

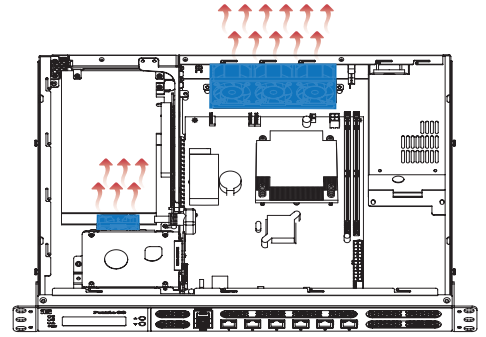

PUZZLE Series

With fan speed and temperature trigger settings set, the fan speed can change seamlessly according to temperature readings.

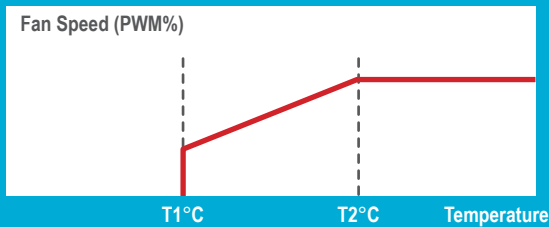

Traditional System

Traditional system fan operation is detected by system's ON (fan at full speed) and OFF statuses.

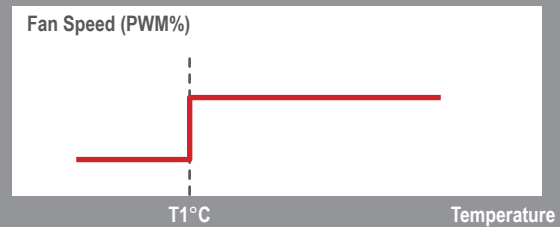

Edge Computing & AI Inference Computing

AI ready with Intel OpenVINO™ toolkit

PUZZLE-IN001 with workstation-class Intel® C246 chipset and cutting edge technology, it allows users to implement "Open Visual Inference & Neural Network Optimization (OpenVINO™) toolkit" to deploy open source deep learning frameworks for Intel® architecture to realize the concept of one SDK for Intel®-based accelerators: CPUs, CPUs with integrated graphics, FPGAs, VPUs, and IPUs. OpenVINO™ toolkit can optimize pre-trained deep learning model such as Caffe, MXNET, Tensorflow into IR binary file then run the inference engine in FPGA acceleration card platforms.

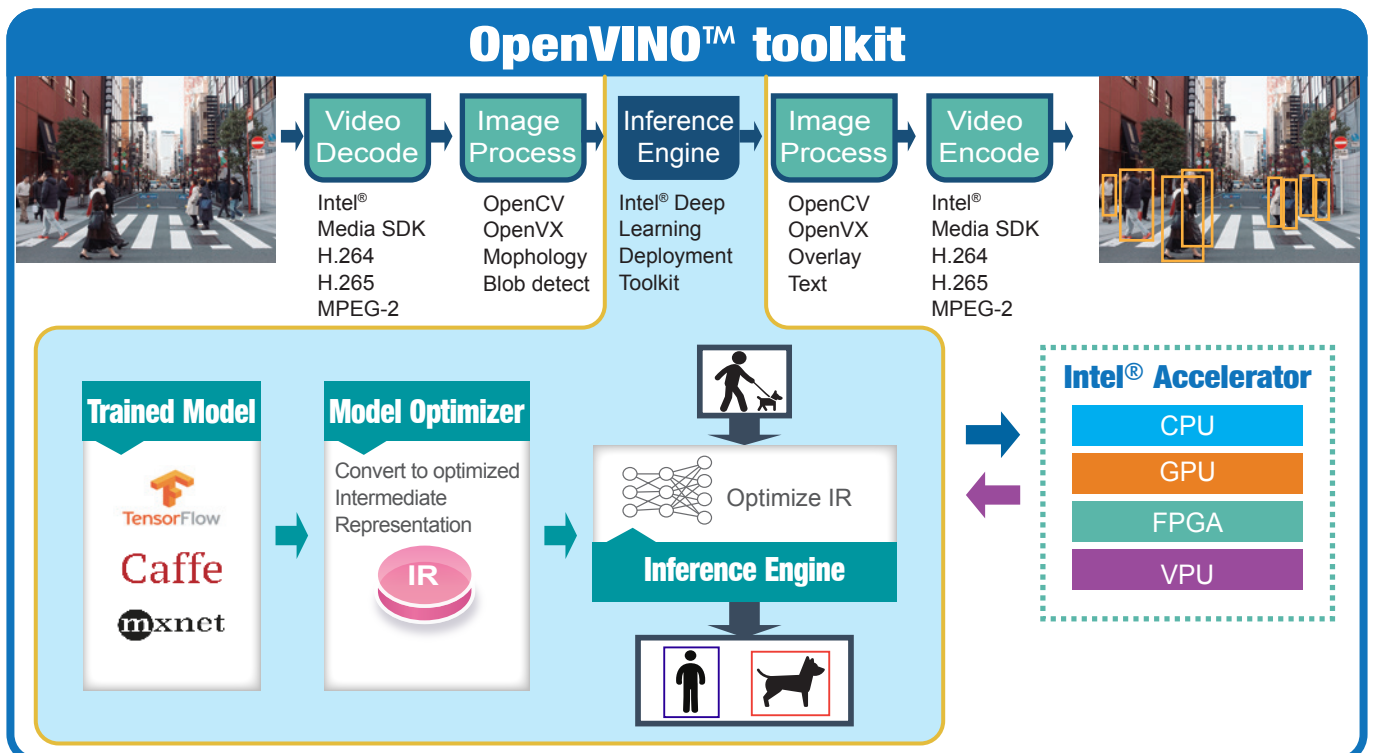

PUZZLE series are perfect for Edge Computing & AI Inference Computing

- Rich interconnectivity to transport big amount of data :
 - **Network interface:** RJ-45, SFP, SFP+, SFP28,
 - **Speed:** 1GbE, 2.5GbE, 5GbE, 10GbE, 25Gb
- Powerful computing capability via smart NIC, VPU, FPGA, GPU cards
- Intel® OpenVINO™ Toolkit supported by PUZZLE-IN001/IN002

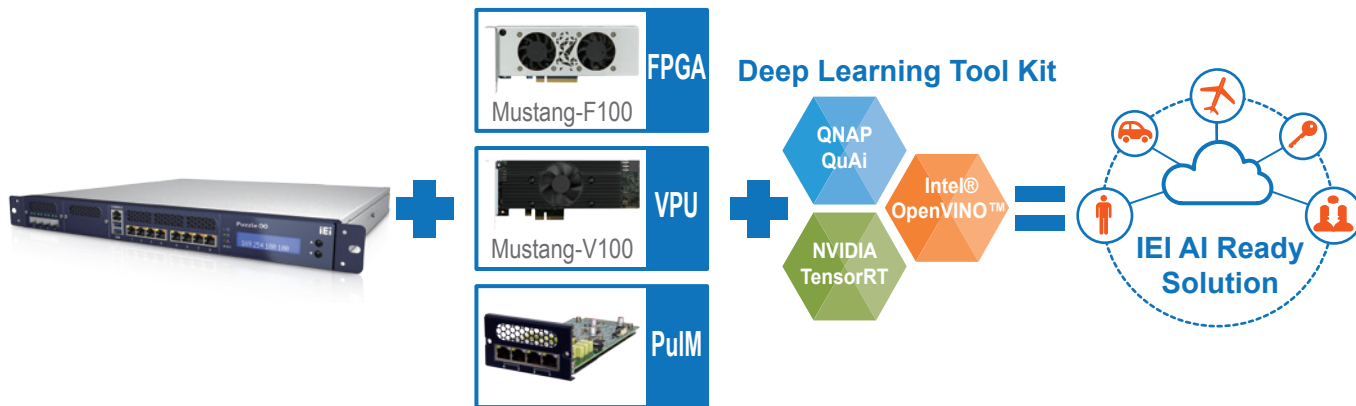

How Does Deep Learning Work?

Deep learning is a machine learning technique that can learn useful representations of features directly from images, text and sound. There are two phases, training and inference. The training servers designed for AI creates patterns and algorithms from the dataset, and each layer of data is assigned some random weights and your classifier runs a forward pass through the data, predicting the class labels and scores using those weights, after the training model is built, that will be applied into systems that are able to predict the result, this is what inference systems do.

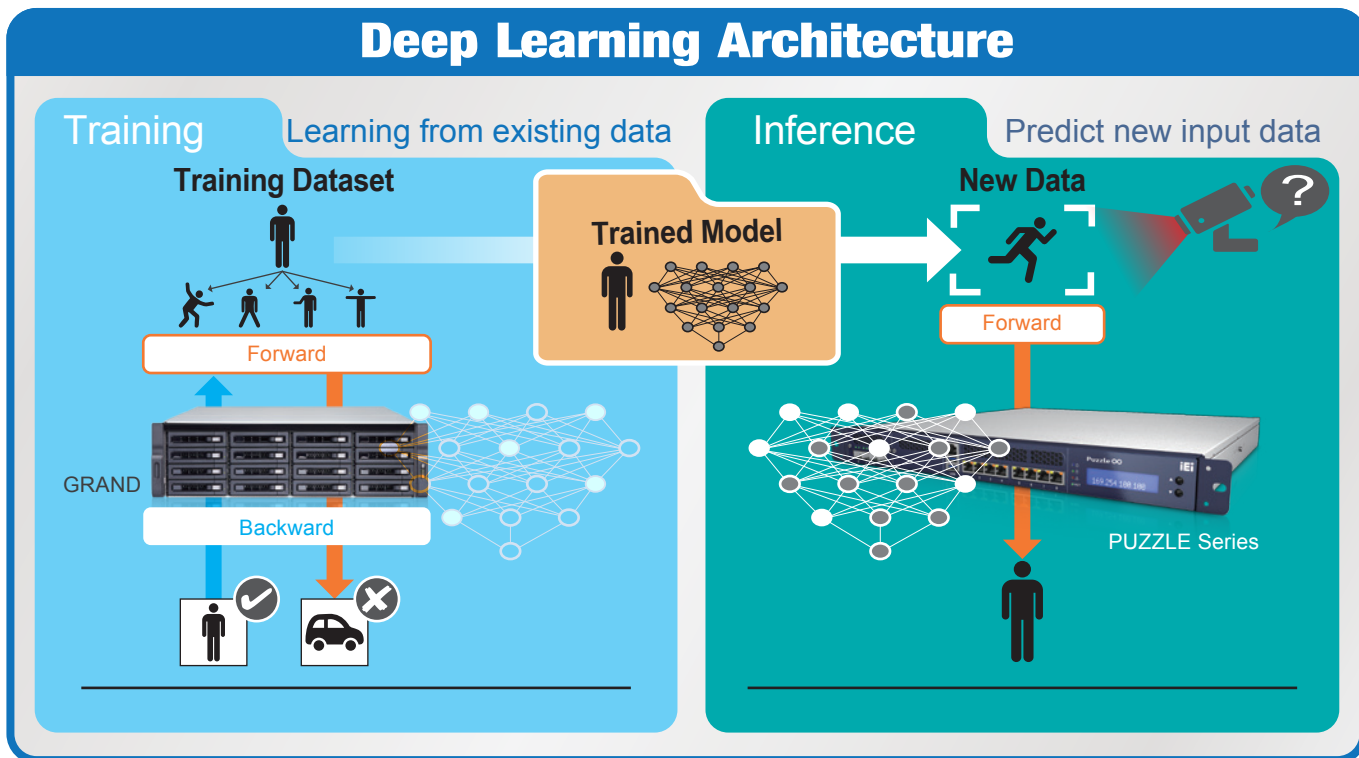

PUZZLE Software Introduction

PUZZLE Finder Software AP

Use your PC/Laptop as a development environment.

After installing Ubuntu 16.04 on your PUZZLE, you can install the PUZZLE Finder application on your PC/Laptop. PUZZLE Finder can help users quickly develop environment and network applications, and allow them to perform PUZZLE system management, resource monitoring, version maintenance, software installation, software update and gaining information of CPU, memory, Internet, etc.

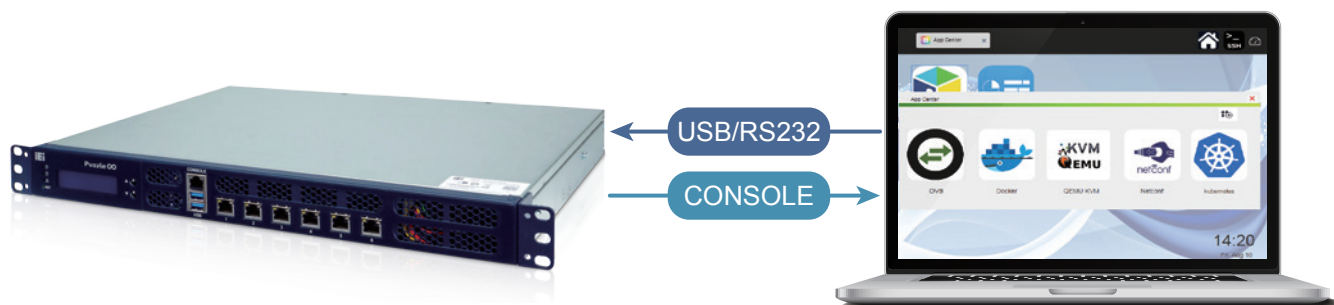

Easy to Install

The APP center provides the most popular and configured applications.

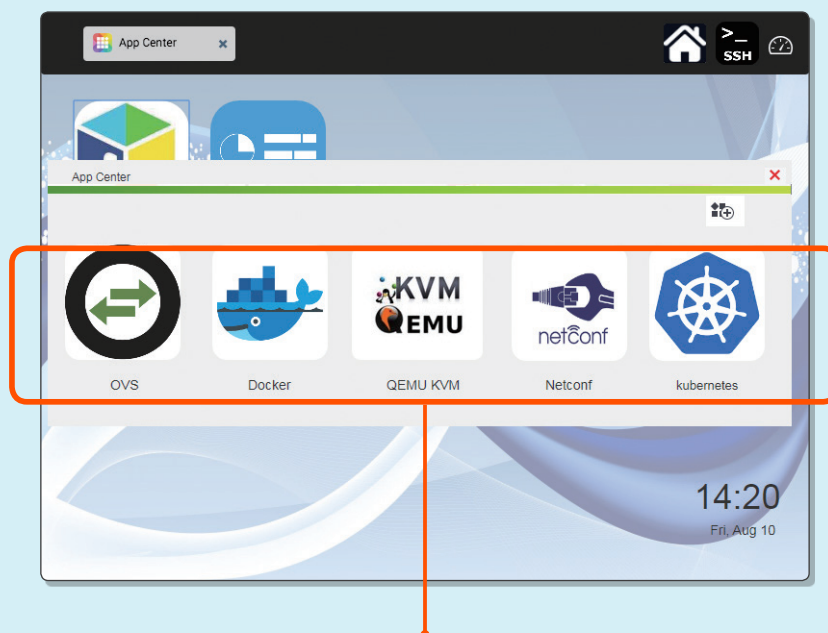

Eliminate cumbersome installation steps; choose the APP you want to install. The APP can be downloaded and automatically installed. You can immediately enjoy the benefits of the software.

Utilize Virtual Technology, Create Unlimited Value

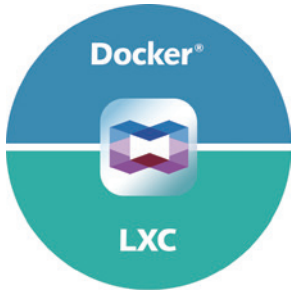

Docker containerization unlocks the potential for Dev and Ops. Freedom of choice, agile operations and integrated security for legacy and cloud-native applications. Implement Docker Lightweight Micro Services on the IEL PUZZLE.

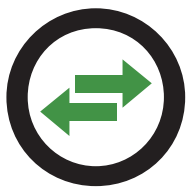

Install the Open vSwitch (OVS) can implement domain cutting, QoS, data monitoring, and support openFlow.



Provide a more efficient Linux virtualization solution. Enhance the efficiency of virtualization by enhancing the operating mode of the CPU through QEMU-KVM.



Automate network configuration with Netconf; accelerate network equipment and services in enterprise in order to lower the cost.



Kubernetes is a system that helps us automate the deployment, expansion, and management of containerized applications.

PUZZLE System Status Monitoring

Graphical user interface allows you to easily get an overview of the PUZZLE system and monitor resource status of each PUZZLE system you have.

User Interface



PUZZLE Series Technology

Virtualization is the process of creating a software-based, or virtual, representation of something, such as virtual applications, servers, storage and networks. Network functions virtualization or NFV is a network architecture concept that uses the technologies of IT virtualization to virtualize entire classes of network node functions into building blocks that may connect, or chain together, to create communication services.

PUZZLE Series Ecosystem

PUZZLE is about the uCPE consists of software virtual network functions (VNFs) running on a standard operating system hosted on an open server. An ideal uCPE deployment supports a multi-vendor multi-component construction and enables rapid development as well as open multi-vendor systems.

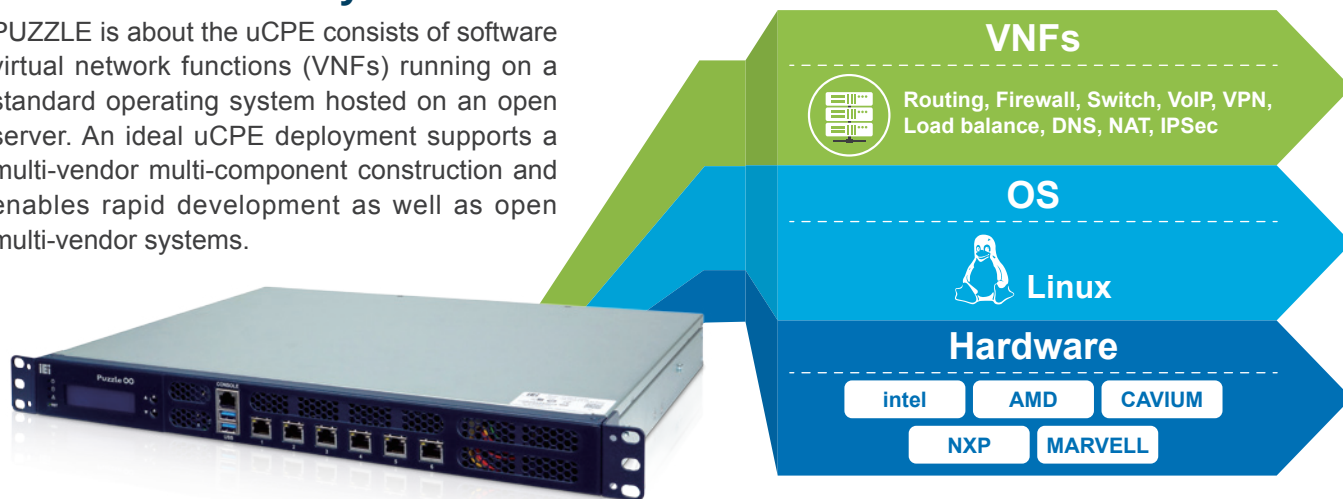

PUZZLE Series is Ready for Next Generation Network

The following picture completely shows the components of the PUZZLE series. Choose the right components from CPU, NIC, software, manufacturing side, and fit them together. You will create a perfect network appliance.

Software/ Application

On the left hand side, it shows the S/W support from IEI. IEI will help customers to get device driver, application, other NFV basic software, DPDK, OvS, VPP, OpenDaylight and OpenStack. IEI will also help customers to deploy and install all of the software and build up their own NFV solutions.



NIC & Bandwidth

On the upper side, it shows the network connection ability of the PUZZLE series. IEI provides four brands of NIC from Aquantia, Intel, Broadcom, Mellanox, and with 1G, 2.5G, 5G, 10G or 25G different kinds of speed.



System Integration

On the right hand side, it shows the computing ability of the PUZZLE series.

IEI implements 5 major CPU brands, including Intel, AMD, Marvell, NXP, Cavium, and 3 kinds of accelerator cards for edge computing or AI computing .



Designing & Manufacture

On the bottom side, it shows ARMOR Link cross IEI cross QNAP.

Most of network appliances are about network security. Some of the customers care about where the network appliance is designed and made. Therefore, we provide you two choices, design and manufacture in Taiwan or in China. QNAP factory is in New Taipei City, Taiwan, and ARMOR Link factory is located in Shanghai, China.

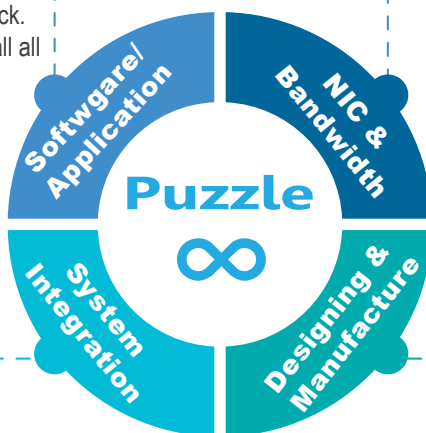

PUZZLE-IN002

1U Rackmount Network Appliance with 8th Generation Intel® Core™ i7/i5/i3, Pentium® or Celeron® Processor, 1 PCIe slots



Features

- 8th Generation Intel® Core™ i7/i5/i3, Pentium® or Celeron® Processor
- Support 6 x GbE RJ45 via Intel® I211
- 2 x DDR4 2400MHz Non-ECC UDIMM, up to 32GB
- 1 x RJ45 Console, 2 x USB 3.0, LCM
- 2 x 2.5" SATA drive bay, 1 x m.2 A key (PCIe & USB 2.0), 1 x PCIe mini card (SATA, USB 2.0) with SIM slot
- Support PCIe x16

Specifications

		PUZZLE-IN002-i3T	PUZZLE-IN002-PGT
Platform	Form Factor	1U	
	CPU	8th Generation Intel® Core™ i3-8100T Processor, 4C/4T, up to 3.10 GHz	Intel® Pentium® Gold G5400T Processor, 2C/4T, up to 3.10 GHz
	Chipset	Intel® H310	
Memory	Memory Technology	2 x DDR4 2400MHz Non-ECC UDIMM	
	Memory Capacity	Up to 32GB	
	Memory Socket	2 x 288-pin DIMM	
Network and Security	Network acceleration and Security function	<ul style="list-style-type: none"> • Intel® AES New Instructions • Intel® Software Guard Extensions (Intel® SGX) • Intel® Memory Protection Extensions (Intel® MPX) • Intel® Trusted Execution Technology 	
	TPM	1 x TPM 2.0 Pin header	
Networking	Ethernet IC	1 GbE NIC: Intel® i211-AT	
	Ethernet Port	6 x 1GbE RJ45 LAN ports	
	Network Module Slot	N/A	
Expansion slot	PCIe slot	1 x PCIe x16 slot	
	PCIe mini card slot	1 x PCIe mini card (SATA, USB 2.0) with SIM slot	
	M.2	1 x m.2 A key (PCIe & USB 2.0)	
Storage	Storage	2 x 2.5" SATA HDD/SSD bay	
	eMMC	N/A	
	SD card	N/A	
External I/O	USB 3.0	2 x USB 3.0	
	Console	1 x RJ45	
Internal I/O	M.2	1 x m.2 A key (PCIe & USB 2.0)	
	HDMI	1 x HDMI connector (optional)	
	USB 3.0	N/A	
	USB 2.0	2 x USB 2.0 (pin header)	
Power and Mechanical	Power Switch	1 x Power Switch	
	Reset Button	1 x Reset Button	
	Power Input	100 V ~ 240 V	
	Type/Watt	ATX Power 250W	
		90V ~ 264V AC	
	Processor Cooling	1 x Passive CPU Heatsink	
	System Cooling	4 x Cooling Fans with Smart Fan	
Antenna Port	1 x Antenna port		
Physical and Environmental	Storage Temperature	-10°C ~ 50°C	
	Operating Temperature	0 ~ 40°C (32 ~ 104°F)	
	Operating Humidity	5% ~ 90% non-condensing	
	Dimensions (W x H x D) (mm)	430 x 320 x 44.2	
	Weight	5kg	
OS and Certifications	Certification	CE / FCC	
	Operating System	Linux Ubuntu 16.04.04	
Indicators	LCM	LCM, 2 buttons	
	LED	1 x Power LED, 1 x Storage LED, 1 x Alert LED	

▶ I/O Interface

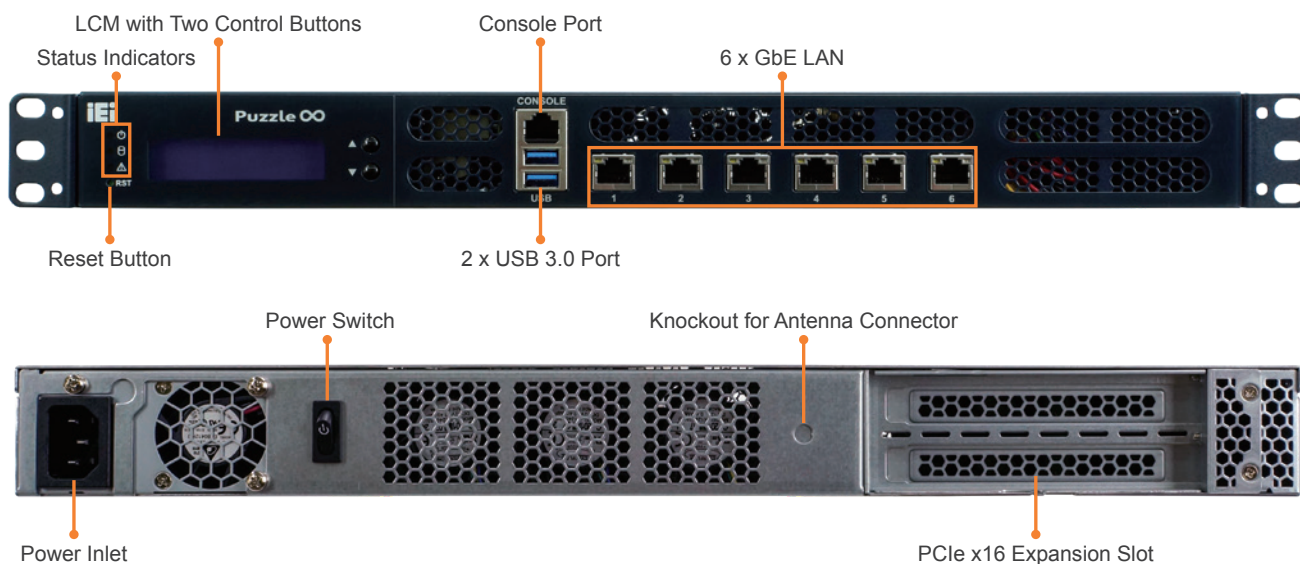

▶ Dimensions (Unit: mm)

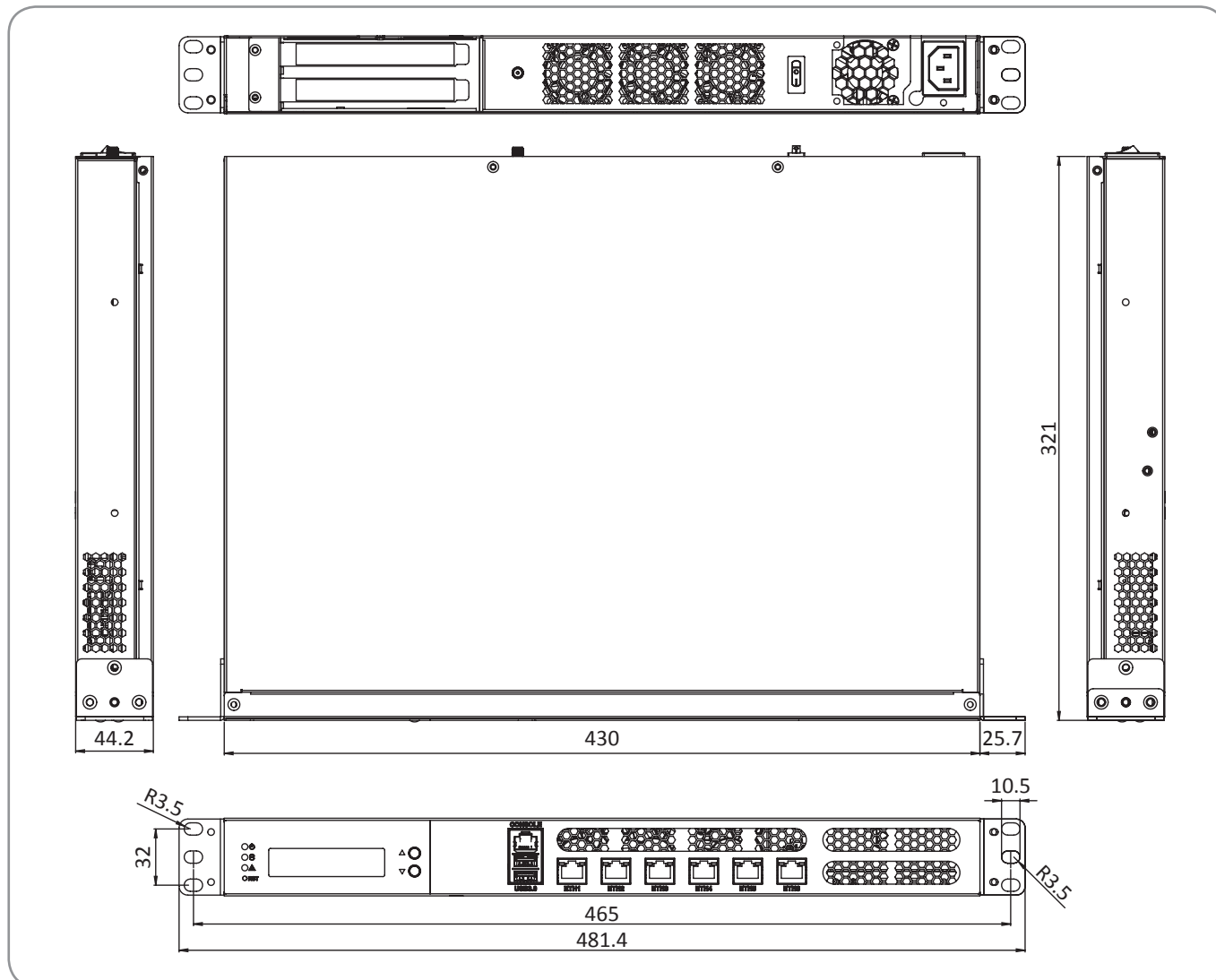

Ordering Information

Part No.	Description
PUZZLE-IN002-i3T-R10	1U Rackmount Network Appliance with Intel® Gen8 Core™ i3-8100T processor, two DDR4 slots, and six 1GbE, one PCIe x16 expansion, RoHS
PUZZLE-IN002-PGT-R10	1U Rackmount Network Appliance with Intel® Gen8 Pentium® Gold G5400T processor, two DDR4 slots, and six 1GbE, one PCIe x16 expansion, RoHS
PUZZLE-IN002-i3T/8G-R10	1U Rackmount Network Appliance with Intel® Gen8 Core™ i3-8100T processor, 8GB DDR4, one 256GB SSD, six 1GbE, one PCIe x16 expansion, RoHS
PUZZLE-IN002-PGT/8G-R10	1U Rackmount Network Appliance with Intel® Gen8 Pentium® Gold G5400T processor, 8GB DDR4, one 256GB SSD, and six 1GbE, one PCIe x16 expansion, RoHS

Packing List

	PUZZLE-IN002-i3T	PUZZLE-IN002-PGT	PUZZLE-IN002-i3T/8G	PUZZLE-IN002-PGT/8G
Power cord	1	1	1	1
Heatsink	1	1	1	1
Rack mounting ears	2	2	2	2
SCREW for Rack mounting ears	6	6	6	6
USB to console cable	Option	Option	1	1
RS232 to console cable	1	1	Option	Option
Slide rail	Option	Option	Option	Option

Options

Item	Part No.	Description
Slide rail	RAIL-B02	New rail kit for new 1U & 2U NAS: TVS-471U, 1253U, etc
USB to console cable	32013-004000-100-RS	ROUND CABLE; LAN CABLE; FTDI Console Cable; 2; 1800MM; (A)USB A TYPE 4P MALE+PCB:FTDI_FT232RL; (B)RJ45 8P8C; RoHS
RS232 to console cable	32005-005100-100-RS	ROUND CABLE; RS-232/422/485; PUZZLE RS-232 Cable; 2; 500MM; 24AWG; (A) D-SUB 9P MALE+#4-40 Screw; (B)RJ45 PLUG 8P8C; ONE PCS PKG; TC&C; RoHS

Headquarters

威強電工業電腦 IEI Integration Corp.

No. 29, Zhongxing Rd., Xizhi Dist., New Taipei City 221, Taiwan
 TEL : +886-2-86916798 / +886-2-26902098 FAX : +886-2-66160028
 sales@ieiworld.com www.ieiworld.com

America

IEI Technology USA Corp.

138 University Parkway, Pomona, CA 91768
 TEL : +1-909-595-2819 FAX : +1-909-595-2816
 sales@usa.ieiworld.com usa.ieiworld.com

China

威強電工業電腦 IEI Integration (Shanghai) Corp.

上海市闵行莘庄工业区申富路515号
 515, Shen Fu Rd., Xin Zhuang Industrial Develop Zone, Shanghai, 201108, China
 TEL:+86-21-3116-7799 FAX:+86-21-3462-7797
 sales@ieiworld.com.cn www.ieiworld.com.cn