

The Most **Reliable** Storage For Industries

SH250-300

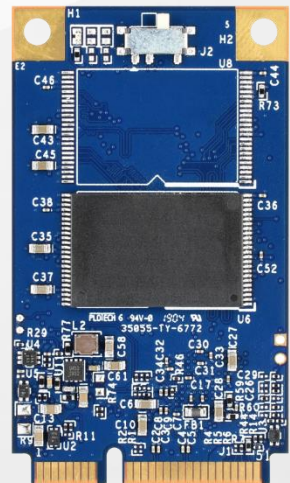

SH250-300

Overview

Apacer's SH250-300 is a well-balanced solid-state disk (SSD) drive with standard form factor and great performance. Designed in SATA 6.0 Gbps interface, the SSD is able to deliver exceptional read/write speed, making it the ideal companion for heavy-loading industrial or server operations.

SH250-300 utilizes 3D NAND for higher capacity up to 160GB and provides more power efficiency than 2D NAND. Appearing in SH250-300 mechanical dimensions, SH250-300 is believed to be the leading add-in storage solution for future host computing systems. Regarding reliability, SH250-300 is implemented with LDPC (Low Density Parity Check) ECC engine to extend SSD endurance and increase data reliability. With Apacer's SLC-liteX technology, SH250-300 performs with higher number of P/E cycles up to 30,000 times. Since it is operating under SATA 6.0 Gbps interface, SH250-300 is provided with Apacer latest S.M.A.R.T. that is primarily oriented for the latest SATA interface SSD, for drive lifetime monitoring and analysis. In addition, the drive comes with various implementations including powerful hardware ECC engine, power saving modes, wear leveling, flash block management, TRIM and DataDefender™.

In terms of security, Advanced Encryption Standard (AES) ensures data security and provide users with a peace of mind knowing their data is safeguarded against unauthorized use at all times. Furthermore, with End-to-End Data Protection, data integrity can be assured at multiple points in the path to enable reliable delivery of data transfers.

Feature

- Low-Density Parity-Check (LDPC) Code
- Global Wear Leveling
- Flash bad-block management
- Flash Translation Layer: Page Mapping
- S.M.A.R.T.
- DataDefender™
- DEVSLP
- ATA Secure Erase
- TRIM
- Hyper Cache Technology
- Over-Provisioning
- SMART Read Refresh™
- SLC-liteX

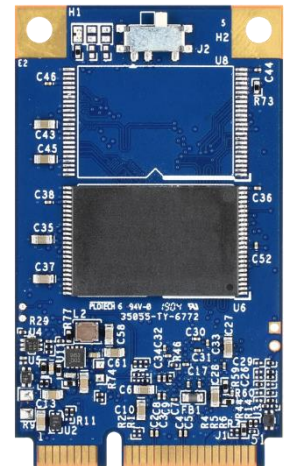

Specifications

Model	SH250-300
Interface	SATA 3.0 (6Gb/s)
Connector	52-pin mSATA connector
Form Factor	JEDEC MO-300
NAND Flash Type	3D TLC
Capacity	10GB~160GB
External DRAM	No
Sustained Read Performance (MB/sec)	Up to 560
Sustained Write Performance (MB/sec)	Up to 520
ECC Engine	Low-Density Parity-Check (LDPC) Code
IOPS (4K Random Write)	75K
Standard Operating Temperature (°C)	0 ~ + 70
Extended Operating Temperature (°C)	-40 ~ + 85
Storage Temperature (°C)	-40 ~ + 100
Thermal Sensor	Yes
Shock	Operation: 50G/11ms Non-operation: 1500G/0.5ms (compliant with MIL-STD-883K)
Vibration	Operation: 7.69 Grms, 20~2000 Hz/random (compliant with MIL-STD-810G) Non-operation: 4.02 Grms, 15 ~ 2000 Hz/sine (compliant with MIL-STD-810G)
Operating Voltage	3.3 V ±5%
Power Consumption	Active mode:415 mA / Idle mode: 65 mA
Dimension (L x W x H)	50.80 x 29.85 x 4.85 (mm)
MTBF (hours)	>1,000,000

Mechanical Specification

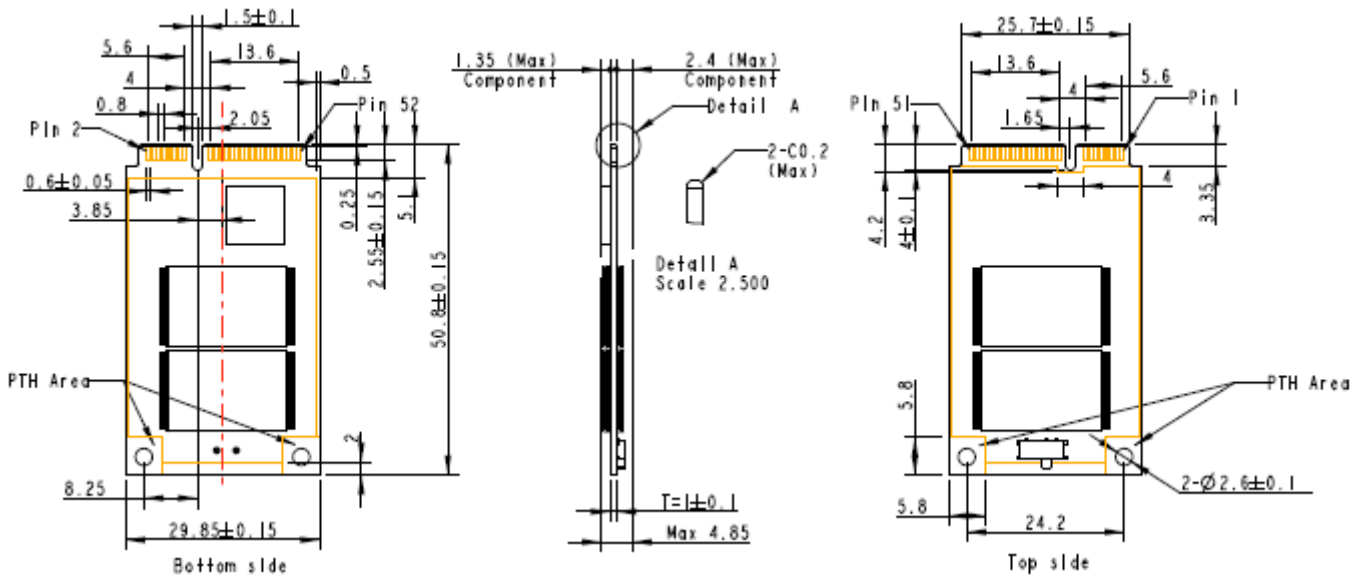

Unit: mm

For more information,
contact your Apacer representative

Global Presence

Taiwan (Headquarters)
Apacer Technology Inc.
Tel: +886-2-2267-8000
Fax: +886-2-2267-2261

Europe
Apacer Technology B.V.
Tel: +31-40-267-0000
Fax: +31-40-290-0686

U.S.A.
Apacer Memory America, Inc.
Tel: +1-408-518-8699
Fax: 1-510-249-9551

China
Apacer Electronic(Shanghai)
Co., Ltd.
Tel: +86-21-6228-9939

Japan
Apacer Technology Corp.
Tel: +81-3-5419-2668
Fax: +81-3-5419-0018

India
Apacer Technologies Pvt. Ltd.
Tel: +91-80-41529061~3
Fax: +91-80-41700215